

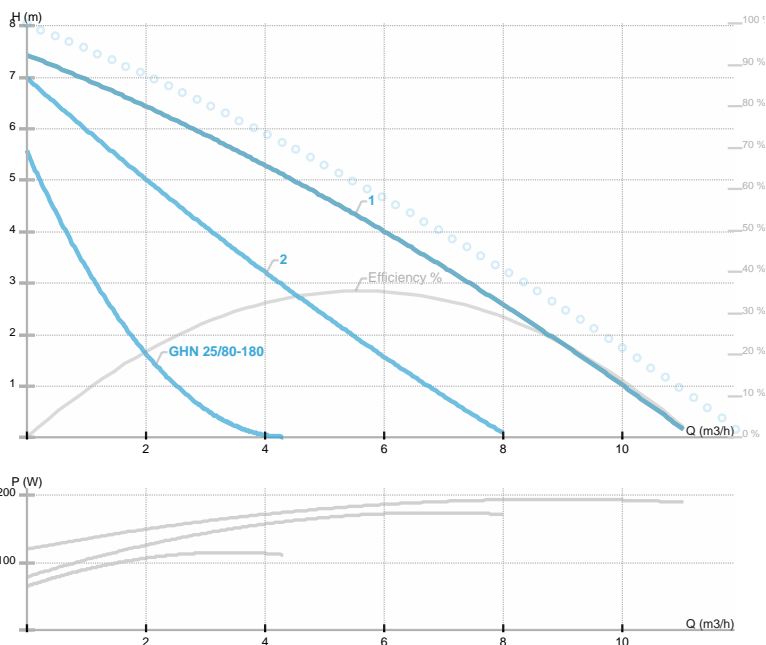

GHN 25/80-180

GHN / Circolatore filettato a tre velocità
 Riscaldamento, Condizionamento



Codice articolo	979523206
Alimentazione	1~230V, 50Hz
Classe di protezione	IP44
Q max	8.4 [m³/h]
H max	8.0 [m]
Giri/min	1150 - 2450 [1/min]
Potenza motore	210 [w]
Corrente nominale	0.95 [A]
Fluidi consentiti	Water VDI 2035, glycol 40%
Temperatura fluido	-10.0 ÷ 110.0 [°C]
Classe di isolamento	H
DN1	25 [mm]
Connettore	Rp 1
Peso	4,60 [kg]
Interasse	180 [mm]
Certificazioni	EAC
EEL	
Efficienza	[%]
Materiale girante	Noryl 1630V
Materiale cuscinetti	Graphite
Materiale albero	AISI 420
Material corpo pompa	Ghisa
Frequenza	50 Hz
Connection	Rp 1
Pressione massima	Max 10 bar
Temperatura max. ambiente	35 deg C

Disegno 1

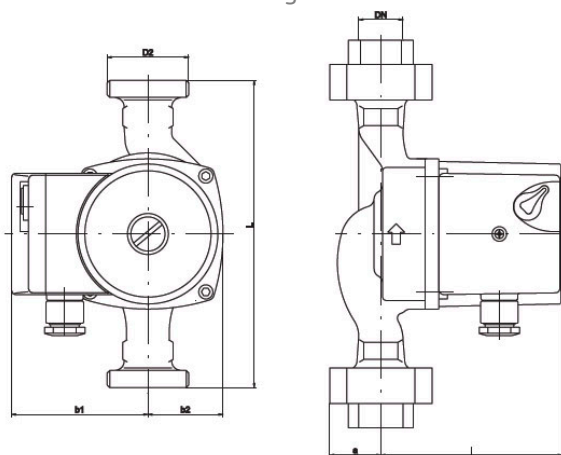

DN=25 D2=1 1/2" L=180 l=108 b1=80 b2=44 a=28

Schema

