

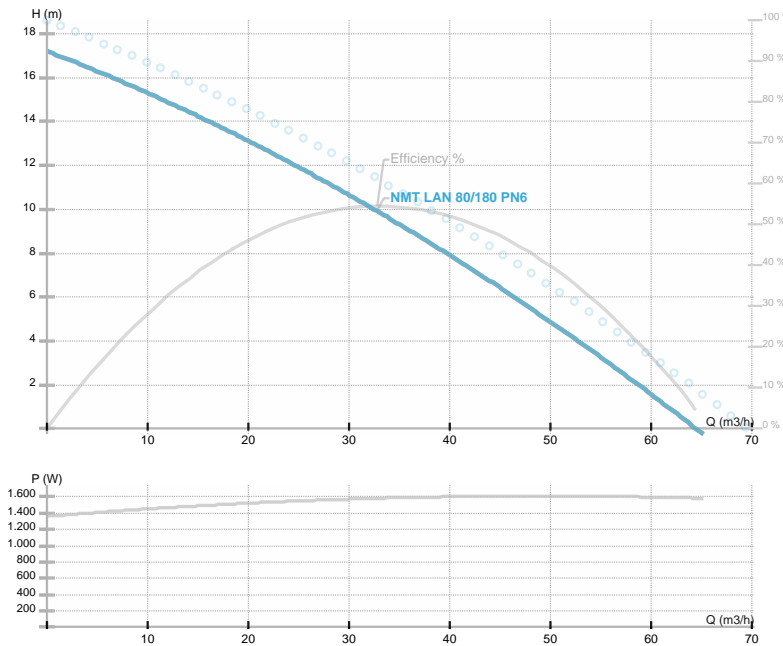

NMT LAN 80/180 PN6

NMT LAN / Circolatore elettronico flangiato
 Riscaldamento



Codice articolo	979523654
Alimentazione	1~230V, 50Hz
Classe di protezione	IP44
Q max	65.6 [m³/h]
H max	17.22 [m]
Giri/min	3400 [1/min]
Potenza motore	1600 [w]
Corrente nominale	8.0 [A]
Fluidi consentiti	Water VDI 2035, glycol 40%
Temperatura fluido	-10.0 ÷ 110.0 [°C]
Classe di isolamento	H
DN1	80 [mm]
Connettore	PN6
Peso	42,00 [kg]
Interasse	360 [mm]
Certificazioni	CE
EEL	0,24
Efficienza	55,18 [%]
Materiale girante	AISI 304
Materiale cuscinetti	Graphite
Materiale albero	AISI 431
Material corpo pompa	Ghisa
Frequenza	47-63 Hz
Connection	PN6
Pressione massima	1.0 MPa
Temperatura max. ambiente	40 deg C

Disegno 1

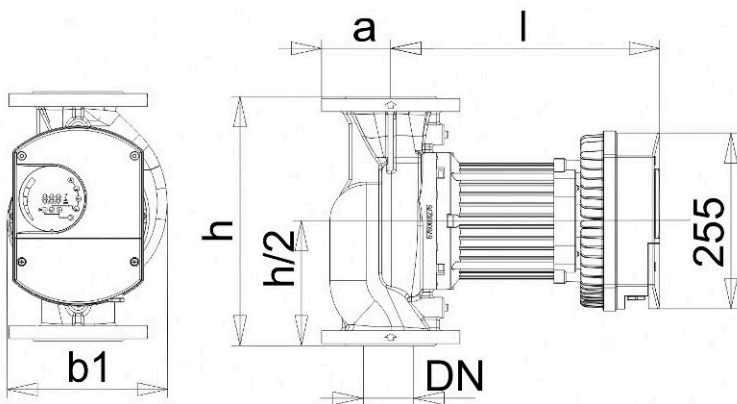

DN=80 b1=230 l=403 h=360 a=100 holes=4

Schema

