

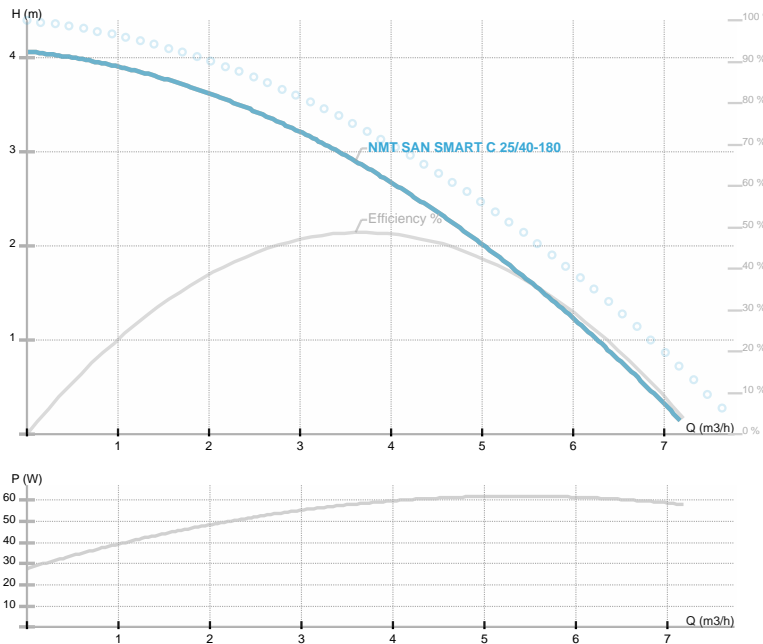

NMT SAN SMART C 25/40-180

NMT SAN SMART C / Circolatore elettronico sanitario con modulo di comunicazione

Acqua sanitaria, Condizionamento



Codice articolo	979524532
Alimentazione	1~230V, 50Hz
Classe di protezione	IP44
Q max	7.22 [m³/h]
H max	4.16 [m]
Giri/min	2800 [1/min]
Potenza motore	60 [w]
Corrente nominale	0.5 [A]
Fluidi consentiti	Water VDI 2035
Temperatura fluido	-10.0 ÷ 110.0 [°C]
Classe di isolamento	F
DN1	25 [mm]
Connettore	Rp 1
Peso	3,50 [kg]
Interasse	180 [mm]
Certificazioni	CE EAC
EEL	0,2
Efficienza	48,91 [%]
Materiale girante	PES GF 30
Materiale cuscinetti	
Materiale albero	AISI 420
Material corpo pompa	Bronzo
Frequenza	50/60 Hz
Connection	Rp 1
Pressione massima	1.0 MPa
Temperatura max. ambiente	40 deg C

Disegno 1

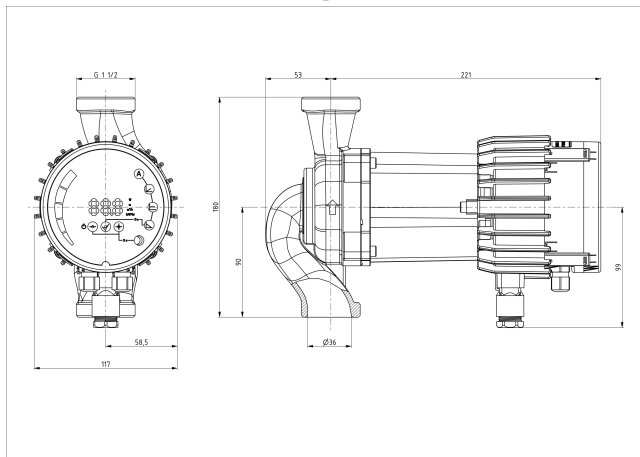

L=180 l=190 DN=25 D2=1 1/2

Schema

