

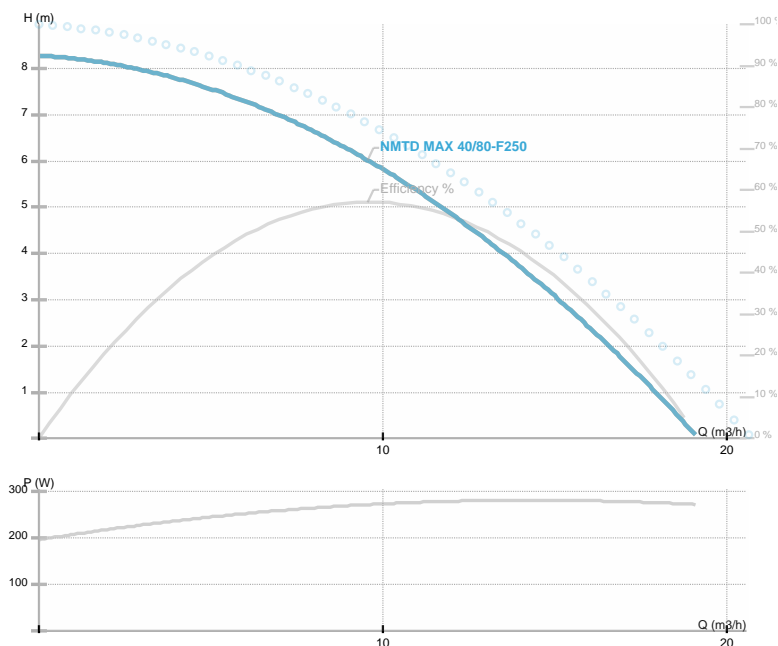

## NMTD MAX 40/80-F250

NMT MAX F / Circolatore elettronico flangiato  
 Riscaldamento



Codice articolo	<b>979524519</b>
Alimentazione	<b>1~230V, 50Hz</b>
Classe di protezione	<b>IP44</b>
Q max	<b>19.11 [m³/h]</b>
H max	<b>8.29 [m]</b>
Giri/min	<b>3700 [1/min]</b>
Potenza motore	<b>270 [w]</b>
Corrente nominale	<b>1.4 [A]</b>
Fluidi consentiti	<b>Water VDI 2035, glycol 40%</b>
Temperatura fluido	<b>-10.0 ÷ 110.0 [°C]</b>
Classe di isolamento	<b>H</b>
DN1	<b>40 [mm]</b>
Connettore	<b>PN 6/10</b>
Peso	<b>17,00 [kg]</b>
Interasse	<b>250 [mm]</b>
Certificazioni	<b>CE EAC</b>
EEL	<b>0,21</b>
Efficienza	<b>57,77 [%]</b>
Materiale girante	<b>PES GF 30</b>
Materiale cuscinetti	<b>Graphite</b>
Materiale albero	<b>AISI 420</b>
Material corpo pompa	<b>Ghisa</b>
Frequenza	<b>50/60 Hz</b>
Connection	<b>PN 6/10</b>
Pressione massima	<b>1.0 MPa</b>
Temperatura max. ambiente	<b>40 deg C</b>

Disegno 1

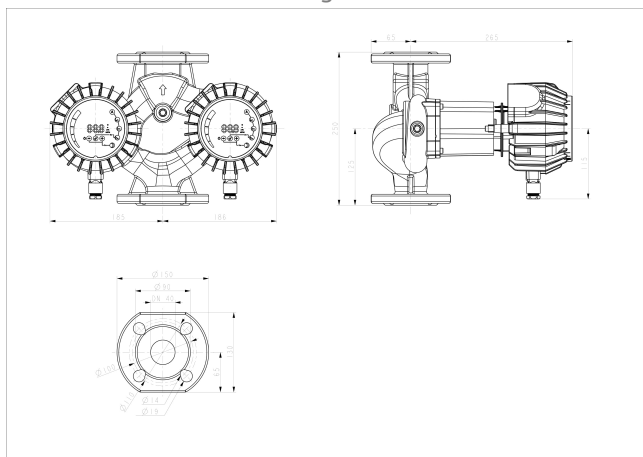

Schema

