

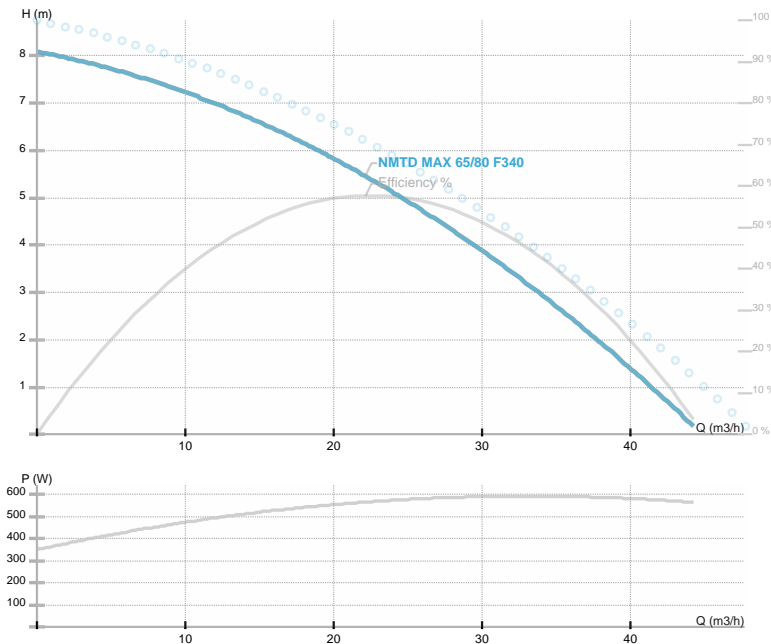

NMTD MAX 65/80 F340

NMT MAX F / Circolatore elettronico flangiato
 Riscaldamento



Codice articolo	979524769
Alimentazione	1~230V, 50Hz
Classe di protezione	IP44
Q max	44.3 [m³/h]
H max	8.09 [m]
Giri/min	3200 [1/min]
Potenza motore	560 [w]
Corrente nominale	2.6 [A]
Fluidi consentiti	Water VDI 2035, glycol 40%
Temperatura fluido	-10.0 ÷ 110.0 [°C]
Classe di isolamento	H
DN1	65 [mm]
Connettore	PN 6/10
Peso	32,40 [kg]
Interasse	340 [mm]
Certificazioni	CE EAC
EEL	0,22
Efficienza	58,2 [%]
Materiale girante	PES GF 30
Materiale cuscinetti	Graphite
Materiale albero	AISI 420
Material corpo pompa	Ghisa
Frequenza	50/60 Hz
Connection	PN 6/10
Pressione massima	1.0 MPa
Temperatura max. ambiente	40 deg C

Disegno 1

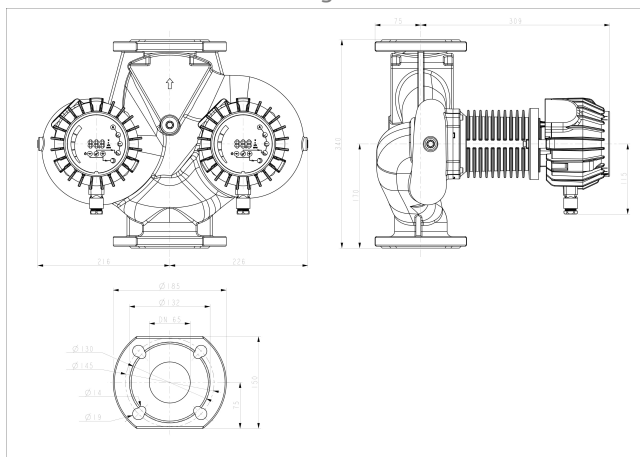

Schema

