

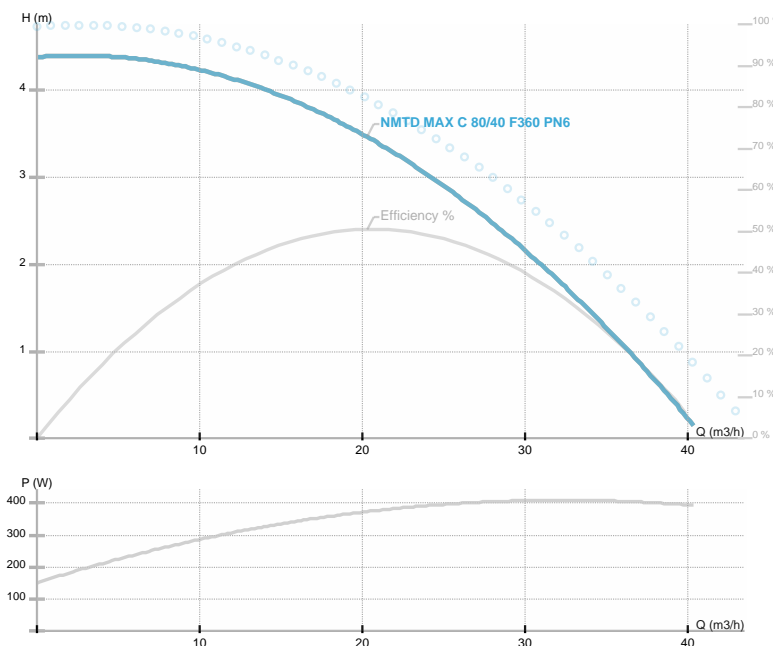

NMTD MAX C 80/40 F360 PN6

NMT MAX C F / Circolatore elettronico flangiato con modulo di comunicazione
Riscaldamento



Codice articolo	979524789
Alimentazione	1~230V, 50Hz
Classe di protezione	IP44
Q max	40.6 [m³/h]
H max	4.38 [m]
Giri/min	2100 [1/min]
Potenza motore	370 [w]
Corrente nominale	1.8 [A]
Fluidi consentiti	Water VDI 2035, glycol 40%
Temperatura fluido	-10.0 ÷ 110.0 [°C]
Classe di isolamento	H
DN1	80 [mm]
Connettore	PN6
Peso	43,20 [kg]
Interasse	360 [mm]
Certificazioni	CE EAC
EEL	0,2
Efficienza	51,04 [%]
Materiale girante	PES GF 30
Materiale cuscinetti	Graphite
Materiale albero	AISI 420
Material corpo pompa	Ghisa
Frequenza	50/60 Hz
Connection	PN6
Pressione massima	1.0 MPa
Temperatura max. ambiente	40 deg C

Disegno 1

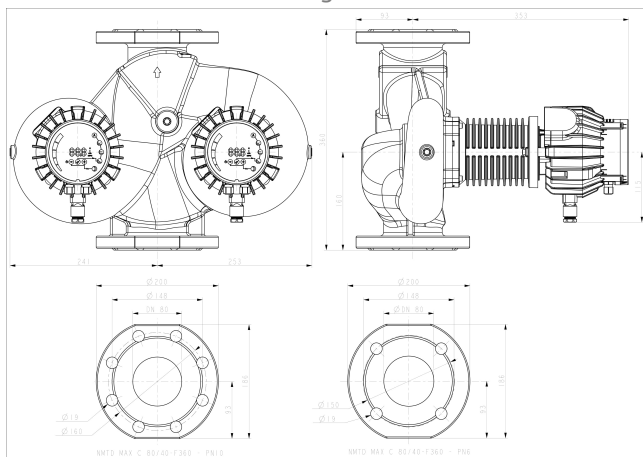

Schema

