

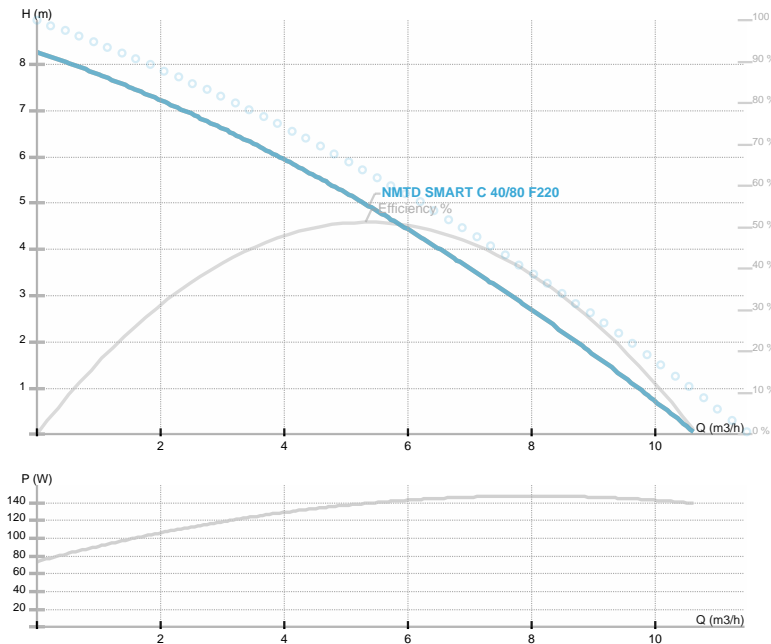

NMTD SMART C 40/80 F220

NMT Smart C / Circolatore elettronico con modulo di comunicazione
Riscaldamento



Codice articolo	979523560
Alimentazione	1~230V, 50Hz
Classe di protezione	IP44
Q max	10.63 [m³/h]
H max	8.6 [m]
Giri/min	4000 [1/min]
Potenza motore	140 [w]
Corrente nominale	1.15 [A]
Fluidi consentiti	Water VDI 2035, glycol 40%
Temperatura fluido	-10.0 ÷ 110.0 [°C]
Classe di isolamento	F
DN1	40 [mm]
Connettore	PN 6/10
Peso	11,40 [kg]
Interasse	220 [mm]
Certificazioni	CE EAC
EEL	0,2
Efficienza	52,05 [%]
Materiale girante	PES GF 30
Materiale cuscinetti	Graphite
Materiale albero	AISI 420
Material corpo pompa	Ghisa
Frequenza	50/60 Hz
Connection	PN 6/10
Pressione massima	1.0 MPa
Temperatura max. ambiente	40 deg C

Disegno 1

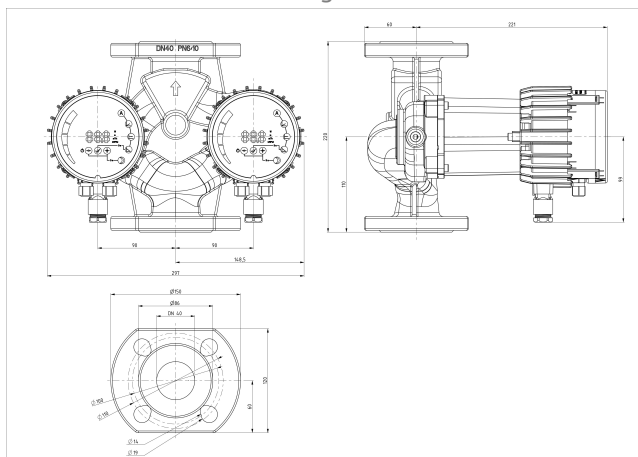

DN=40 h=220 a=75 l=190

Schema

