

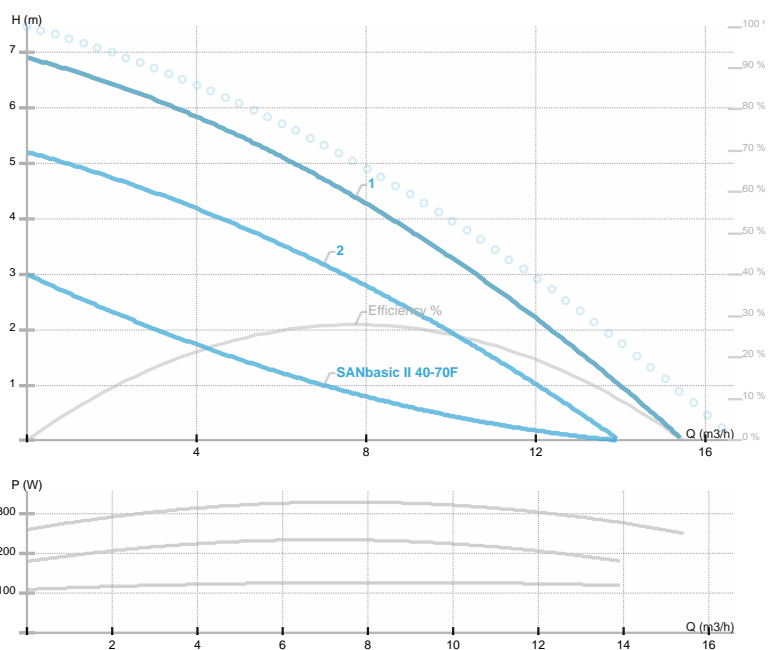

SANbasic II 40-70F

SANbasic / Circolatore sanitario flangiato a tre velocità
 Acqua sanitaria



Codice articolo	979524617
Alimentazione	3~400V, 50Hz
Classe di protezione	IP44
Q max	13.0 [m³/h]
H max	6.0 [m]
Giri/min	1440 - 2790 [1/min]
Potenza motore	317 [w]
Corrente nominale	0.74 [A]
Fluidi consentiti	Water VDI 2035
Temperatura fluido	-10.0 ÷ 65.0 [°C]
Classe di isolamento	200
DN1	40 [mm]
Connettore	PN 6/10
Peso	20,30 [kg]
Interasse	250 [mm]
Certificazioni	EAC
EEL	
Efficienza	[%]
Materiale girante	Noryl 1630V
Materiale cuscinetti	Graphite
Materiale albero	AISI 431
Material corpo pompa	Bronzo
Frequenza	50 Hz
Connection	PN 6/10
Pressione massima	
Temperatura max. ambiente	40 deg C

Disegno 1

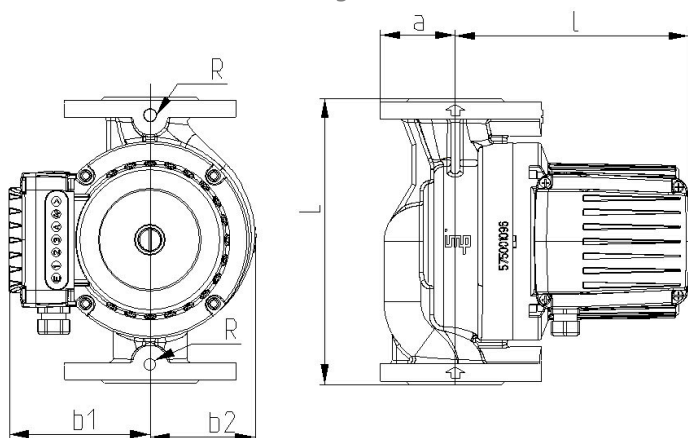

DN=40 L=250 a=65 l=198 b1=125 b2=92 R=1/4

Schema

