

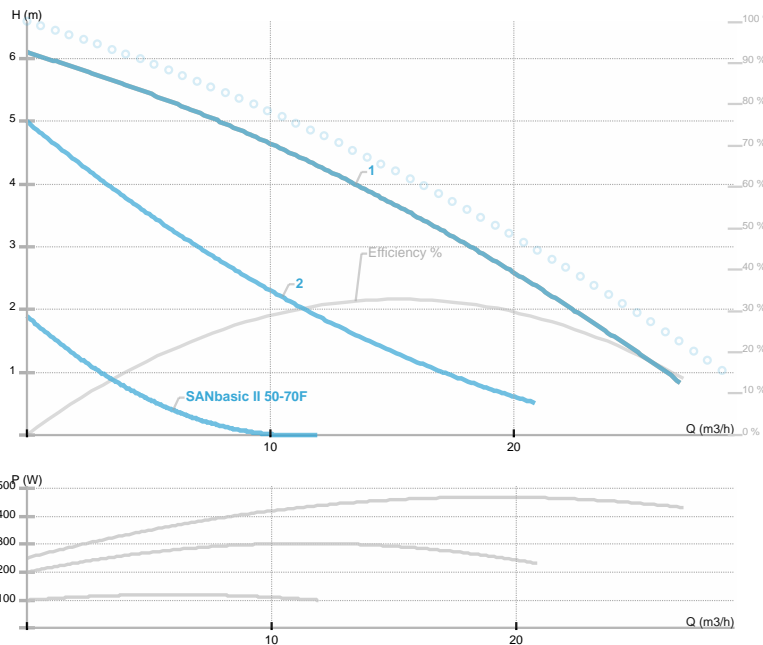

SANbasic II 50-70F

SANbasic / Circolatore sanitario flangiato a tre velocità
 Acqua sanitaria



Codice articolo	979524619
Alimentazione	3~400V, 50Hz
Classe di protezione	IP44
Q max	25.0 [m³/h]
H max	6.0 [m]
Giri/min	560 - 1400 [1/min]
Potenza motore	465 [w]
Corrente nominale	1.13 [A]
Fluidi consentiti	Water VDI 2035
Temperatura fluido	-10.0 ÷ 65.0 [°C]
Classe di isolamento	200
DN1	50 [mm]
Connettore	PN 6/10
Peso	27,30 [kg]
Interasse	280 [mm]
Certificazioni	EAC
EEL	
Efficienza	[%]
Materiale girante	AISI 304
Materiale cuscinetti	Graphite
Materiale albero	AISI 431
Material corpo pompa	Bronzo
Frequenza	50 Hz
Connection	PN 6/10
Pressione massima	
Temperatura max. ambiente	40 deg C

Disegno 1

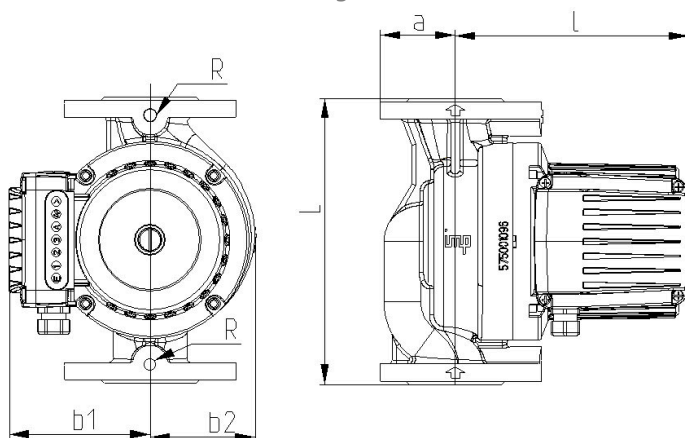

DN=50 L=280 a=70 l=220 b1=130 b2=123 R=1/4

Schema

