

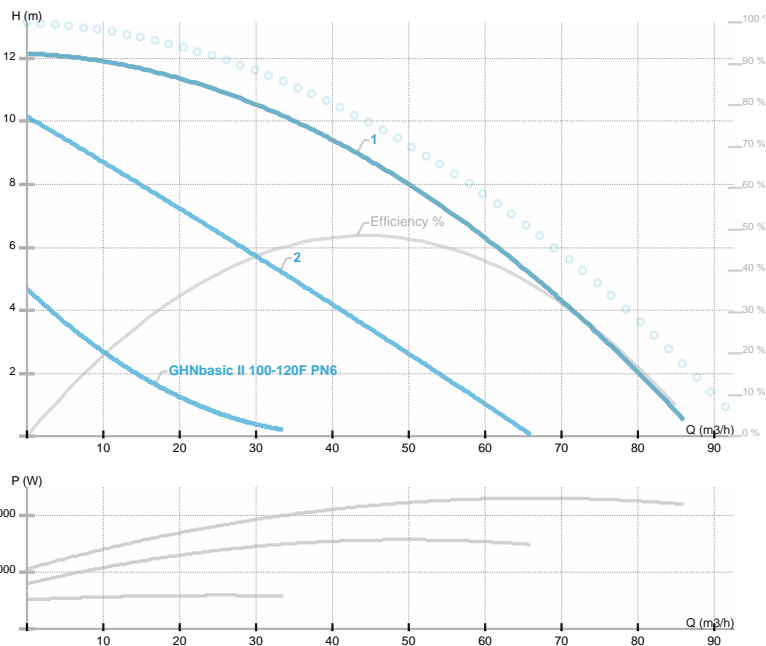

GHNbasic II 100-120F PN6

GHNbasic / Circolatore flangiato a tre velocita'
 Riscaldamento



Codice articolo	979524474
Alimentazione	3~400V, 50Hz
Classe di protezione	IP44
Q max	75.0 [m³/h]
H max	11.5 [m]
Giri/min	1200 - 2800 [1/min]
Potenza motore	2324 [w]
Corrente nominale	4.0 [A]
Fluidi consentiti	Water VDI 2035, glycol 50%
Temperatura fluido	-10.0 ÷ 120.0 [°C]
Classe di isolamento	200
DN1	100 [mm]
Connettore	PN6
Peso	38,30 [kg]
Interasse	360 [mm]
Certificazioni	EAC
EEL	
Efficienza	[%]
Materiale girante	AISI 304
Materiale cuscinetti	Graphite
Materiale albero	AISI 431
Material corpo pompa	Ghisa
Frequenza	50 Hz
Connection	PN6
Pressione massima	
Temperatura max. ambiente	40 deg C

Disegno 1

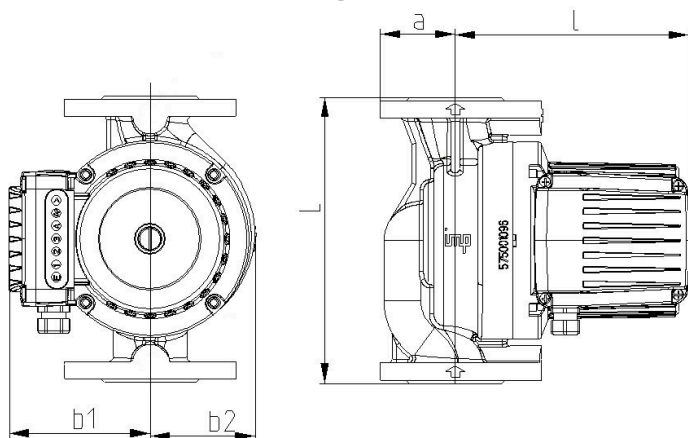

DN=100 L=360 a=110 l=257 b1=130 b2=130 R=1/4

Schema

