

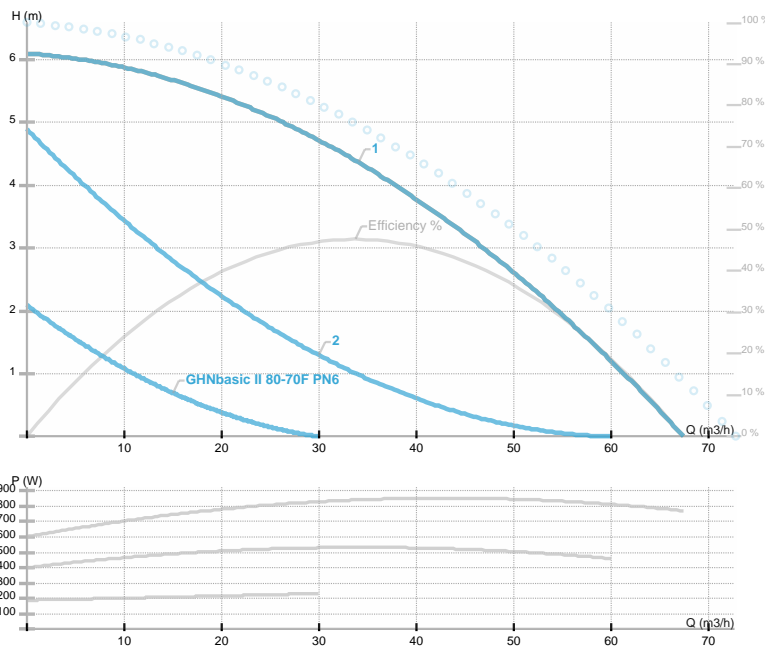

GHNbasic II 80-70F PN6

GHNbasic / Circolatore flangiato a tre velocita'
 Riscaldamento



Codice articolo	979524471
Alimentazione	3~400V, 50Hz
Classe di protezione	IP44
Q max	70.0 [m³/h]
H max	6.0 [m]
Giri/min	600 - 1350 [1/min]
Potenza motore	1002 [w]
Corrente nominale	2.2 [A]
Fluidi consentiti	Water VDI 2035, glycol 50%
Temperatura fluido	-10.0 ÷ 120.0 [°C]
Classe di isolamento	200
DN1	80 [mm]
Connettore	PN6
Peso	33,40 [kg]
Interasse	360 [mm]
Certificazioni	EAC
EEI	
Efficienza	[%]
Materiale girante	AISI 304
Materiale cuscinetti	Graphite
Materiale albero	AISI 431
Material corpo pompa	Ghisa
Frequenza	50 Hz
Connection	PN6
Pressione massima	
Temperatura max. ambiente	40 deg C

Disegno 1

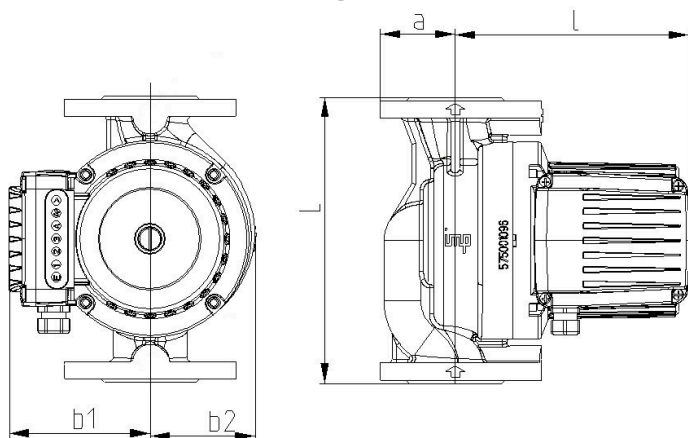

DN=80 L=360 a=100 l=259 b1=130 b2=129,5 R=1/4

Schema

